

Specifications interMED 5500VA

Medical isolation transformer

InterMED medical isolation transformers are used to insulate electrical devices, which are used in surgeries, from the main electrical network. They eliminate possibility of the electric shock to the patients or medical personnel.

interMED products are known for their excellent quality and reliability. Several hundred units are installed in many Finnish and foreign hospitals and health centers.

Leakage current in transformers is very low and products fulfill all required norms and standards. All transformers are designed and manufactured in Finland.



<i>Primary</i>	230Vac or 400Vac
<i>Secondary</i>	115Vac - 0 - 115Vac
<i>Rating</i>	5500 VA 23,9 A
<i>Frequency</i>	47 - 63Hz
<i>Protection degree</i>	Class 1
<i>Test voltage</i>	3,5 kV (1 min, 50 Hz) between windings and earth and screen.
<i>Leakage current</i>	≤ 0,5 mA (output winding to earth, enclosure to earth, earth leakage current)
<i>Enclosure</i>	IP23, with Pg knockouts, RAL 7032
<i>Thermal Class</i>	F (155°C)
<i>Ambient temperature</i>	25°C
<i>Cooling</i>	ANAN
<i>Dimensions, weight</i>	335 x 375 x 500mm, 44 kg
<i>Standards</i>	IEC/EN61558-1 / 61558-2-15, EN60601-1
<i>Accessories</i>	Thermal control / protection device. Current transformer for MEV-7. Test measuring terminals for current transformer.

Dimensions:

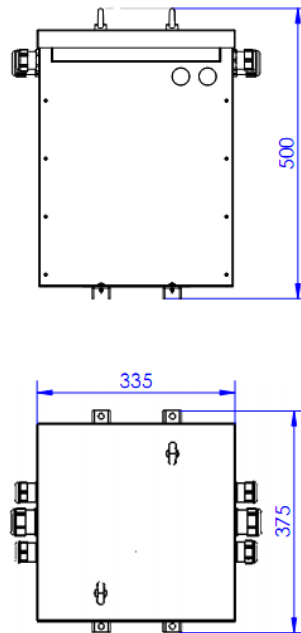

Circuit diagram:

